



Installation Instructions for: 3002-CR

FRAME PARTS LIST:

1. Existing Electrical Box
2. Wire
3. Ground Wire
4. Threaded Pipe
5. Crossbar
6. Crossbar Screws (from your Electrical Box)
7. Canopy Cup
8. Canopy Nut Lock
9. Chain
10. Crown
11. Long Arm
12. Short Arm
13. Screws
14. E12 Bulbs

DIMENSIONS:

Length: 24"  
Width: 24"  
Height: 24"

Weight: 38 lbs  
Bulb Type: E12  
No. of lights: 11

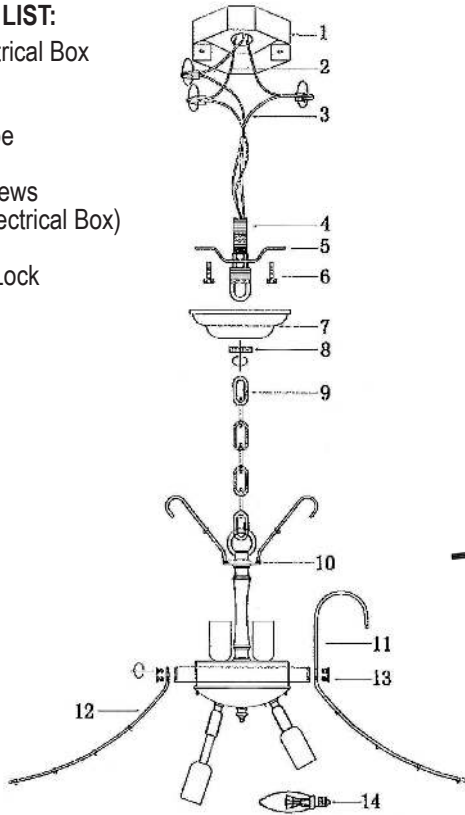

IMPORTANT SAFETY INSTRUCTIONS:

1. Use an authorized and certified electrician for consultation and installation.
2. The screws need to be screwed into a solid support structure inside the ceiling, which would require professional installation.
3. This fixture has been rated for 40-watt maximum E12 standard bulb.
4. To avoid the risk of fire, do not exceed the recommended wattage.
5. The manufacturer and distributor accepts no liability for incorrect installation.
6. For indoor use only.
7. Keep away from children.

WARNINGS:

1. Turn off electricity supply at main circuit panel before installing. Do not connect electricity supply until your ceiling light is fully assembled and installed.
2. All wires are connected. Do not remove the ceiling light from its packaging by pulling on the power cord, as a bad connection may result.
3. To reduce the risk of fire, electrical shock, or personal injury, always turn off the ceiling light and allow it to cool prior to replacing light bulb. Do not touch bulb when fixture is turned on or look directly at light bulb. Keep flammable materials away from light bulb.
4. Deviation from instructions may result in a risk of fire or electric shock.

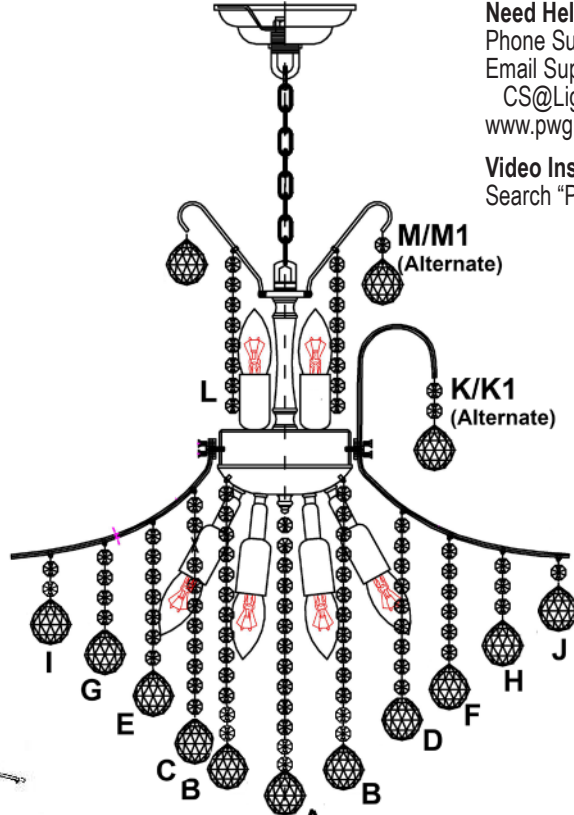

ASSEMBLY INSTRUCTIONS:

1. Remove fixture frame and white crystal packaging from box.
2. On a clean, padded workspace – use the screws included along the frame’s center ring to attach the included Long and Short Arms in an alternating pattern. Starting at any point, remove one pair of screws and attach a Long Arm, lining up the holes and using the same pair of screws to affix the arm to the frame. Then, in the space beside it, attach a Short Arm using the same method. Proceed around the frame’s center ring, alternating between arms, until all are attached.
3. With all arms attached, the frame is fully assembled. Mount to existing electrical box using the screws from your existing electrical box. Attach wires from the fixture to your electrical box with guidance or assistance from a licensed installer or handyman.
4. Once the frame has been mounted, attach included light bulbs, then check that all lightbulbs are functioning before proceeding to dressing the frame with the included crystal set.
5. Attach crystal strands A-M1 as per the included diagram, then attach a 40mm crystal ball at the end of each hanging crystal strand, except from crystal strand L.

CARE INSTRUCTIONS:

1. Make sure that the power is turned off and bulb has cooled before handling.
2. Wipe clean with a dry cloth or feather duster to remove dust.
3. If dust does not wipe off, remove the dirty crystals and soak in cleaning solutions for 20 minutes. Do not return crystals to fixture while wet. Do not use corrosive or ammonia-based cleaners.

Need Help?

Phone Support: (855) 303-4500  
Email Support:  
CS@LightingByPecaso.com  
www.pwglighting.com

Video Instructions:

Search “Pecaso 3002” on YouTube!



MODEL NUMBER

**3002-CR**

CRYSTAL DETAIL

40 mm. Balls

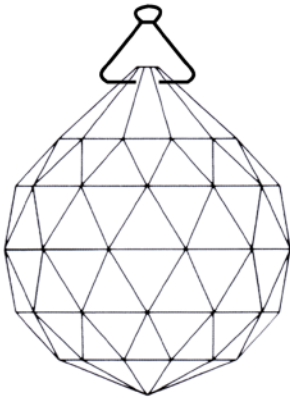

QUANTITY: 109

**A**

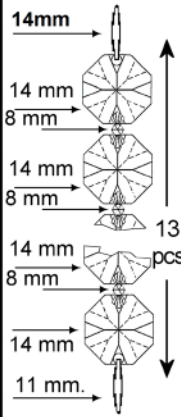

QUANTITY: 1

**B**

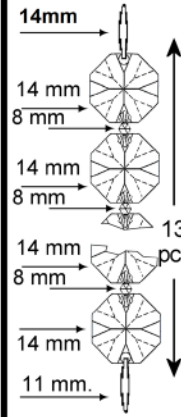

QUANTITY: 8

**C**

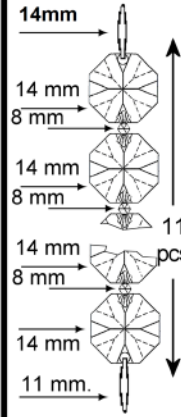

QUANTITY: 10

**D**

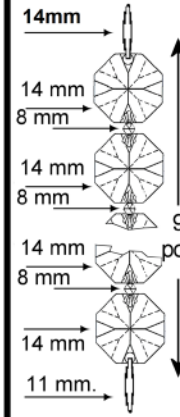

QUANTITY: 10

**E**

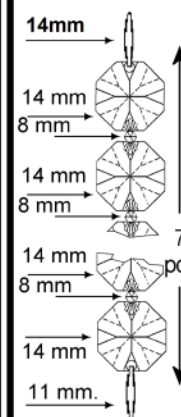

QUANTITY: 10

**F**

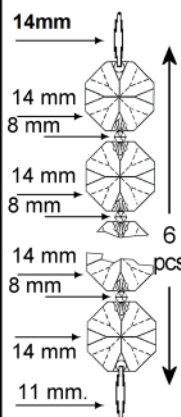

QUANTITY: 10

**G**

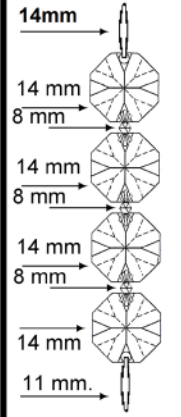

QUANTITY: 10

**H**

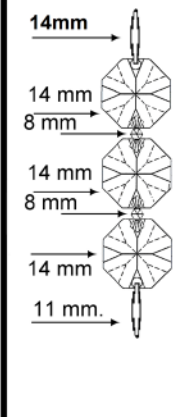

QUANTITY: 10

**I**

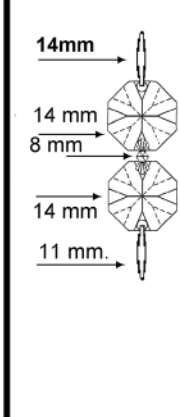

QUANTITY: 10

**J**

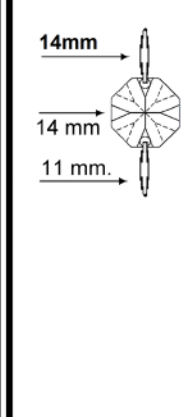

QUANTITY: 10

**K**

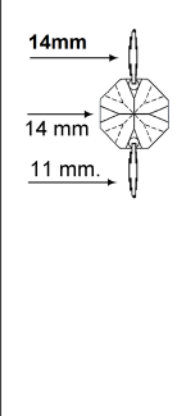

QUANTITY: 5

**K1**

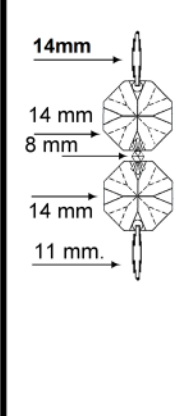

QUANTITY: 5

**L**

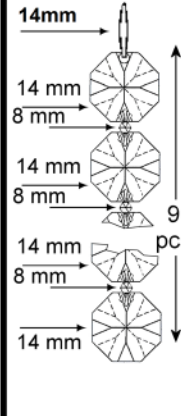

QUANTITY: 10

**M**

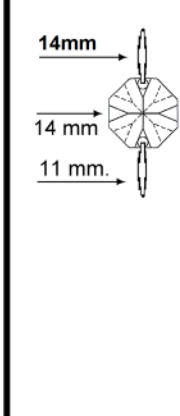

QUANTITY: 5

**M1**



QUANTITY: 5